



INSTALLATION MANUAL

Club 322F

Club 3412T

Club 422F

Club 522F

Club 602C

Club 602CTP

Club 620F

Club 622

Club 6422F

Club 8622F

Club 9632

Club 322F

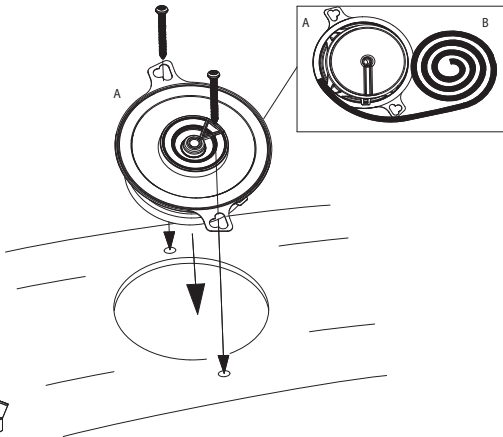
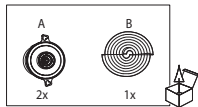
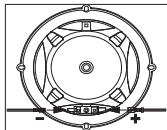

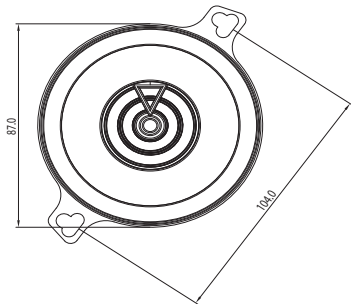
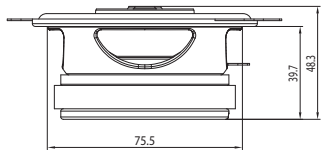

Specifications

- Type: 3-1/2" (87mm) Two-Way Car Speaker
- Power Handling: 25W RMS, 75W peak
- Sensitivity (@ 2.83V/m): 89dB
- Frequency Response: 90Hz – 20kHz
- Nominal Impedance: 3.0 ohms

Thiele-Small Parameters

- BL (Tm): 2.873
- DCR (ohms): 2.26
- Mms (g): 3.723
- Sd (cm²): 44.18
- Cms (μm/N): 0.491
- Vas (l): 1.3574
- Fs (Hz): 117.7
- Qes: 0.755
- Qms: 7.777
- Qts: 0.688
- Crossover Point: 4kHz

Club 3412T

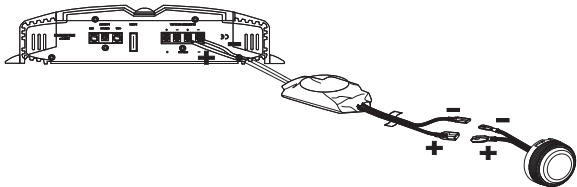
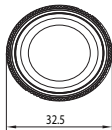
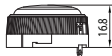

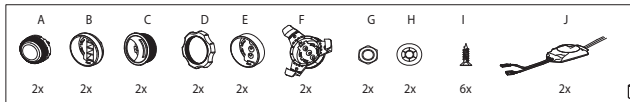
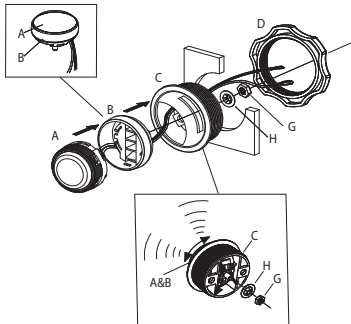
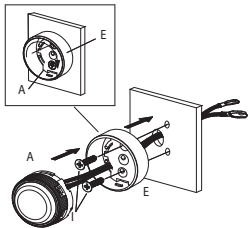

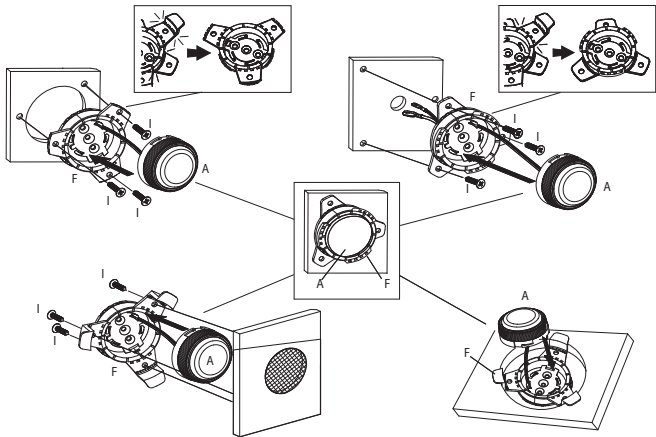

Specifications

- Type: 3/4" (19mm) Edge-Driven dome tweeter
- Power Handling: 50W RMS, 150W peak
- Sensitivity (@ 2.83V): 92dB
- Frequency Response: 3kHz – 20kHz
- Nominal Impedance: 3.0 ohms

Club 422F

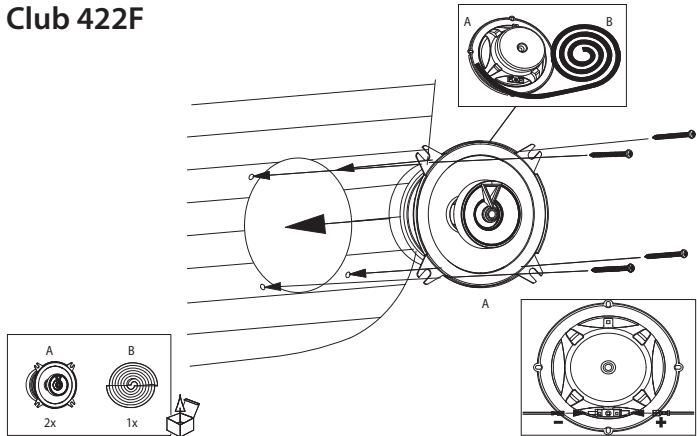

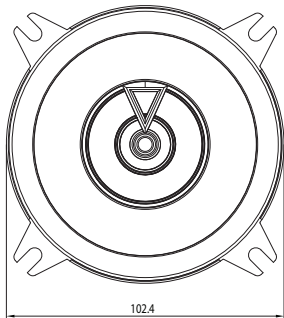
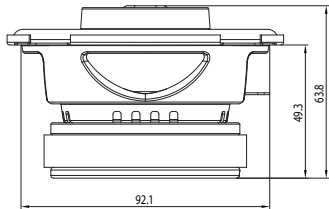

Specifications

- Type: 4" (100mm) Two-Way Car Speaker
- Power Handling: 35W RMS, 105W peak
- Sensitivity (@ 2.83V): 90dB
- Frequency Response: 75Hz – 20kHz
- Nominal Impedance: 3.0 ohms

Thiele-Small Parameters

- BL (Tm): 3.783
- DCR (ohms): 2.46
- Mms (g): 6.608
- Sd (cm²): 63.62
- Cms (μm/N): 0.750
- Vas (l): 4.2937
- Fs (Hz): 71.5
- Qes: 0.510
- Qms: 6.495
- Qts: 0.473
- Crossover Point: 3kHz

Club 522F

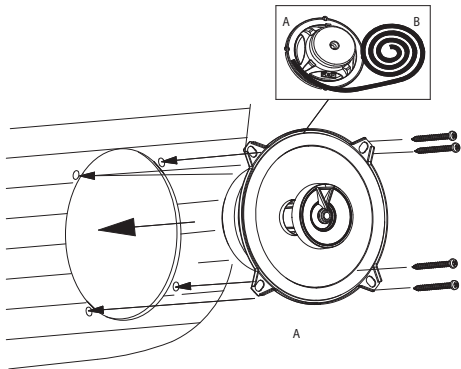
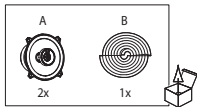
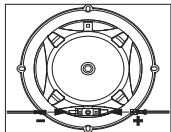

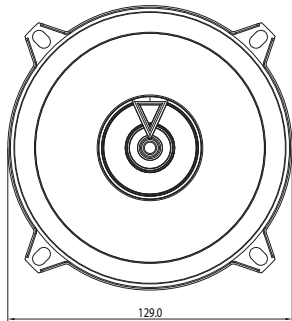
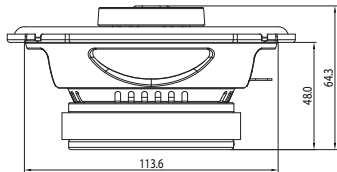

Specifications

- Type: 5-1/4" (130mm) Two-Way Car Speaker
- Power Handling: 45W RMS, 135W peak
- Sensitivity (@ 2.83V): 91dB
- Frequency Response: 75Hz – 20kHz
- Nominal Impedance: 3.0 ohms

Thiele-Small Parameters

- BL (Tm): 3.563
- DCR (ohms): 2.24
- Mms (g): 9.484
- Sd (cm²): 103.87
- Cms (μm/N): 0.274
- Vas (l): 4.1850
- Fs (Hz): 98.7
- Qes: 1.036
- Qms: 8.608
- Qts: 0.925
- Crossover Point: 3kHz

Club 602C

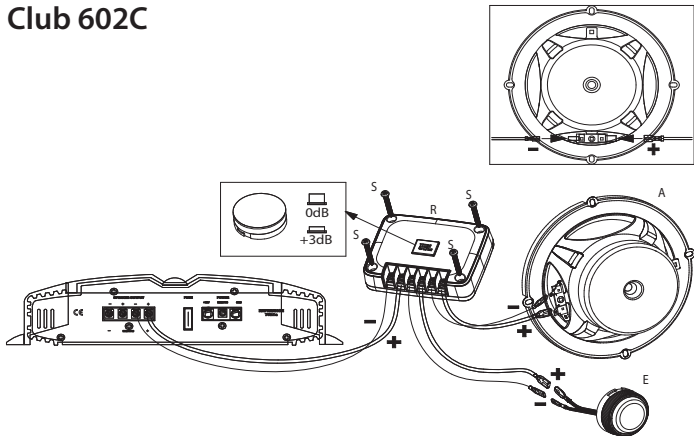

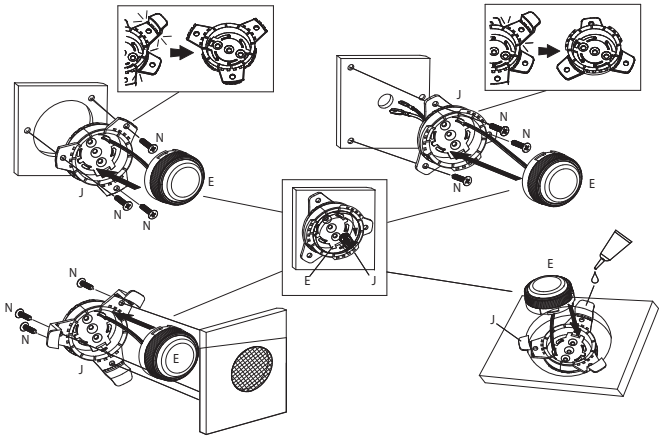

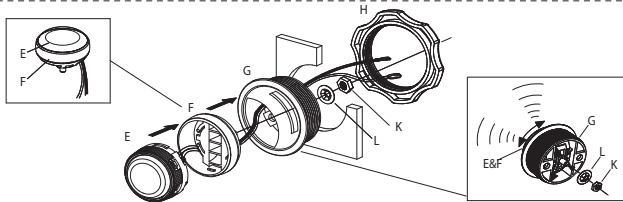
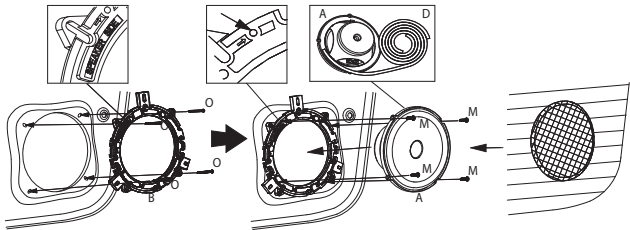

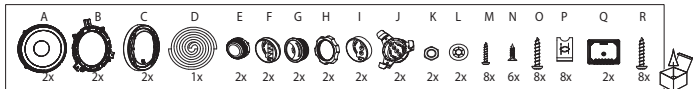
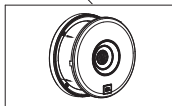
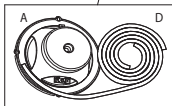
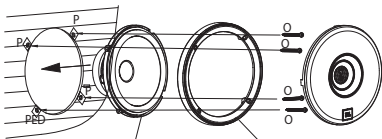
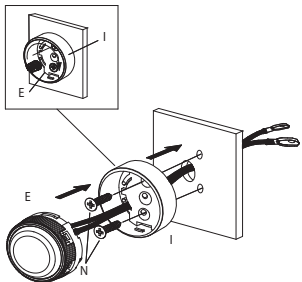

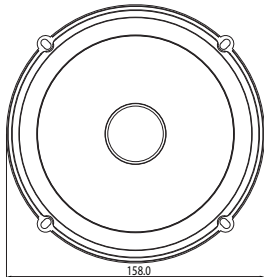
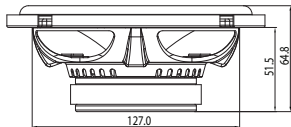
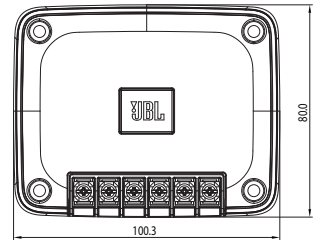

Specifications

- Type: 6-1/2" (160mm) Two-Way Component Speaker System
- Power Handling: 70W RMS, 210W peak
- Sensitivity (@ 2.83V): 92dB
- Frequency Response: 55Hz – 20kHz
- Nominal Impedance: 3.0 ohms

Thiele-Small Parameters

- BL (Tm): 3.635
- DCR (ohms): 2.37
- Mms (g): 14.409
- Sd (cm²): 132.73
- Cms (μm/N): 0.257
- Vas (l): 6.4107
- Fs (Hz): 82.7
- Qes: 1.340
- Qms: 10.965
- Qts: 1.194
- Crossover Point: 5.5kHz

Club 602CTP

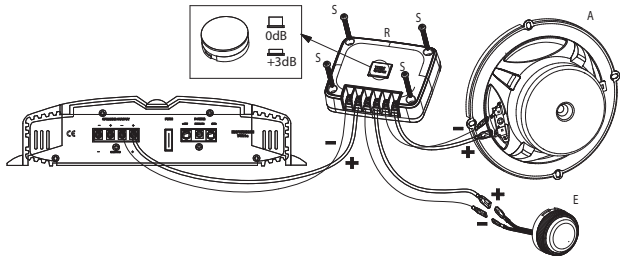
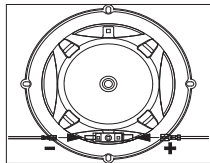

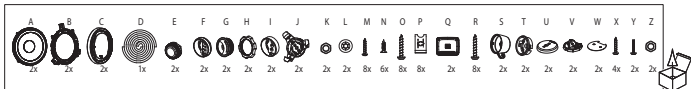
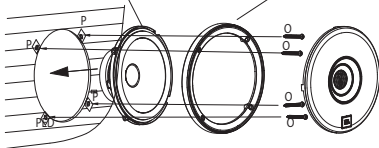
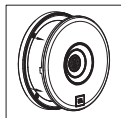
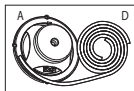
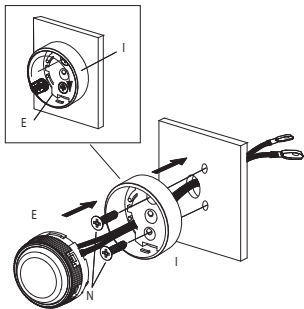

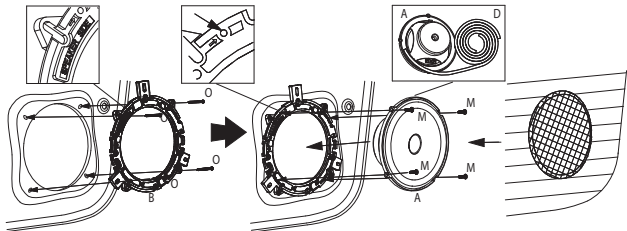

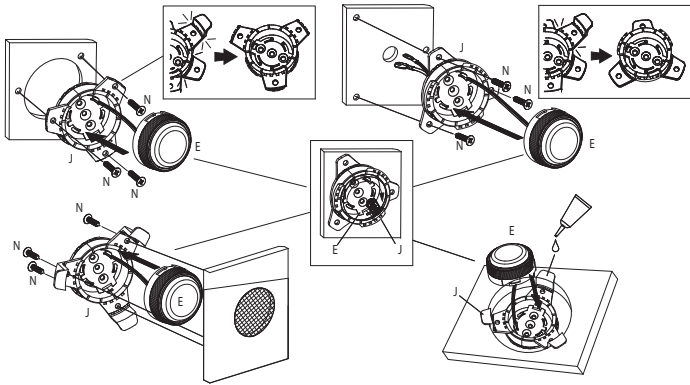

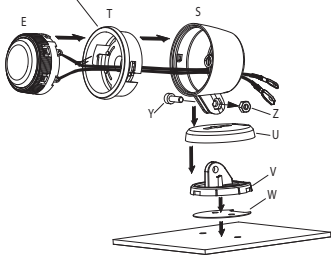
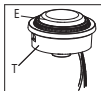
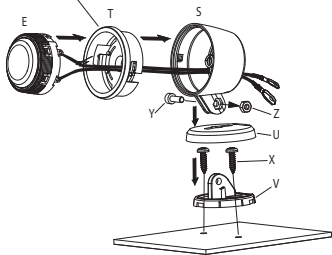
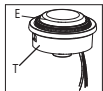

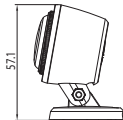
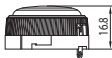
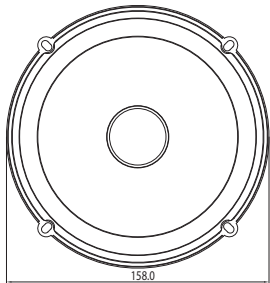
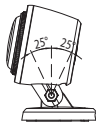
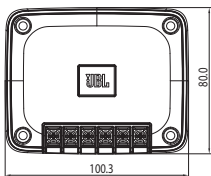
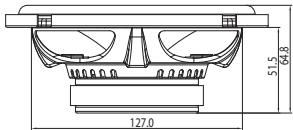

Specifications

- Type: 6-1/2" (160mm) Two-Way Component Speaker System with tweeter Pod
- Power Handling: 70W RMS, 210W peak
- Sensitivity (@ 2.83V): 92dB
- Frequency Response: 55Hz – 20kHz
- Nominal Impedance: 3.0 ohms

Thiele-Small Parameters

- BL (Tm): 3.635
- DCR (ohms): 2.37
- Mms (g): 14.409
- Sd (cm²): 132.73
- Cms (μm/N): 0.257
- Vas (l): 6.4107
- Fs (Hz): 82.7
- Qes: 1.340
- Qms: 10.965
- Qts: 1.194
- Crossover Point: 5.5kHz

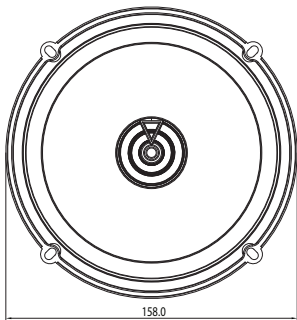
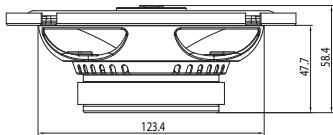

Specifications

- Type: Shallow-Mount 6-1/2" (160mm) Two-Way Car Speaker
- Power Handling: 55W RMS, 165W peak
- Sensitivity (@ 2.83V): 92dB
- Frequency Response: 55Hz – 20kHz
- Nominal Impedance: 3.0 ohms

Thiele-Small Parameters

- BL (Tm): 3.739
- DCR (ohms): 2.41
- Mms (g): 9.934
- Sd (cm²): 122.72
- Cms (μm/N): 0.278
- Vas (l): 5.9287
- Fs (Hz): 95.7
- Qes: 1.032
- Qms: 11.357
- Qts: 0.946
- Crossover Point: 4kHz

Club 622

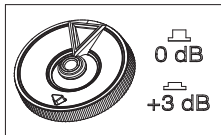
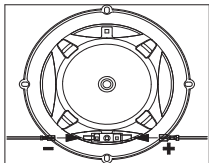

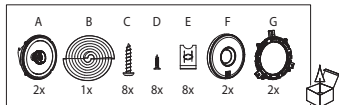
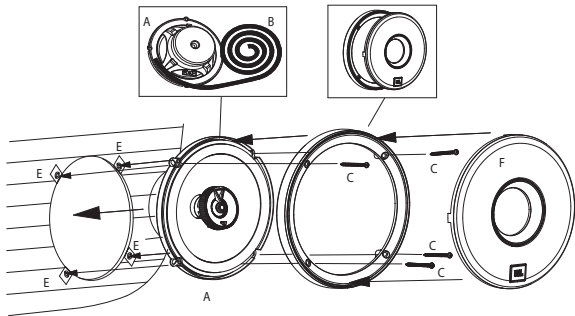

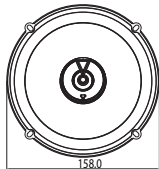
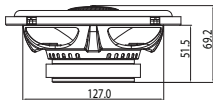
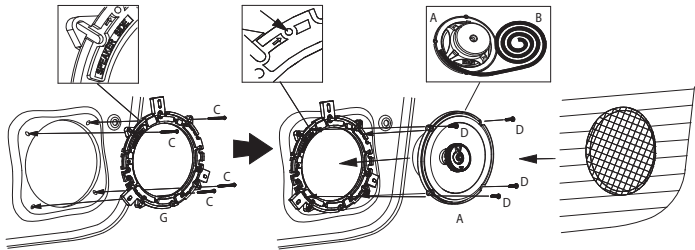

Specifications

- Type: 6-1/2" (160mm) Two-way Car Speaker , Engineered For Better Sound Performance.
- Power Handling: 60W RMS, 180W peak
- Sensitivity (@ 2.83V): 93dB
- Frequency Response: 48Hz – 21kHz
- Nominal Impedance: 3.0 ohms

Thiele-Small Parameters

- BL (Tm): 3.632
- DCR (ohms): 2.36
- Mms (g): 13.758
- Sd (cm²): 132.73
- Cms (μm/N): 0.378
- Vas (l): 9.4253
- Fs (Hz): 69.8
- Qes: 1.080
- Qms: 10.655
- Qts: 0.980
- Crossover Point: 3.5kHz

Club 6422F

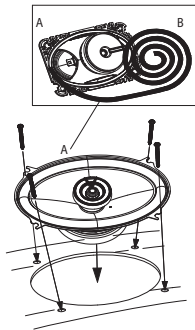
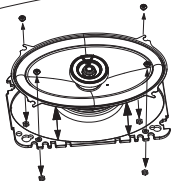
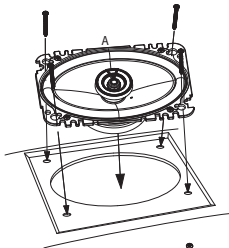
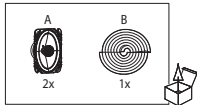
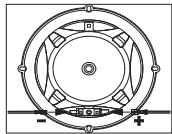

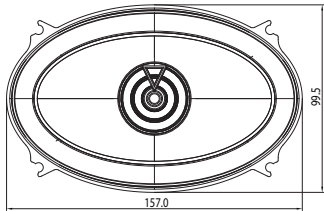
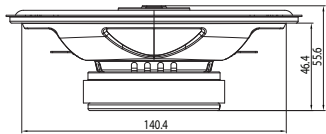

Specifications

- Type: 4"x 6" (100mm x 152mm) Two-Way Car Speaker
- Power Handling: 40W RMS, 120W peak
- Sensitivity (@ 2.83V): 92dB
- Frequency Response: 75Hz – 20kHz
- Nominal Impedance: 3.0 ohms

Thiele-Small Parameters

- BL (Tm): 3.296
- DCR (ohms): 2.5
- Mms (g): 7.86
- Sd (cm²): 86.59
- Cms (μm/N): 0.245
- Vas (l): 2.5977
- Fs (Hz): 114.7
- Qes: 1.303
- Qms: 12.752
- Qts: 1.182
- Crossover Point: 3kHz

Club 8622F

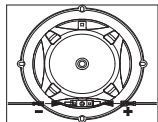
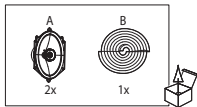
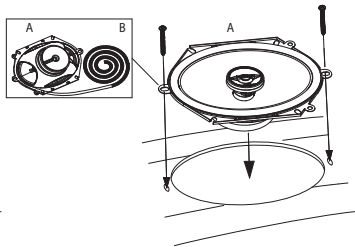
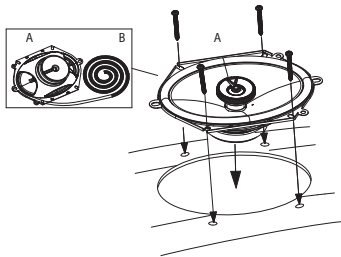

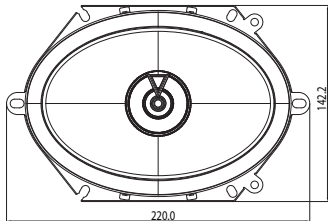
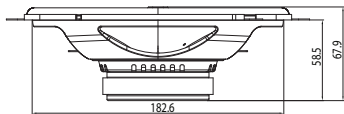

Specifications

- Type: 6"x8" (152mm x 203mm) two-way car speaker, no grille
- Power Handling: 60W RMS, 180W peak
- Sensitivity (@ 2.83V): 93dB
- Frequency Response: 65Hz – 20kHz
- Nominal Impedance: 3.0 ohms

Thiele-Small Parameters

- BL (Tm): 3.785
- DCR (ohms): 2.39
- Mms (g): 17.718
- Sd (cm²): 165.13
- Cms (μm/N): 0.336
- Vas (l): 12.9798
- Fs (Hz): 65.2
- Qes: 1.210
- Qms: 14.592
- Qts: 1.118
- Crossover Point: 3.5kHz

Club 9632

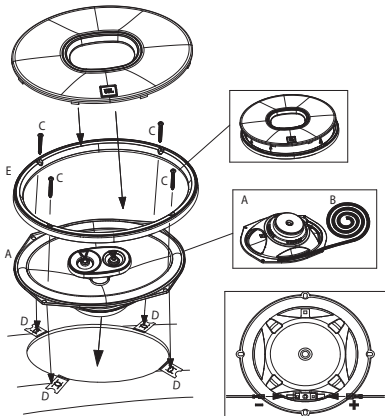
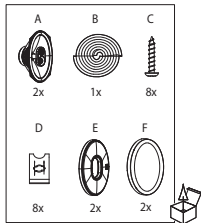

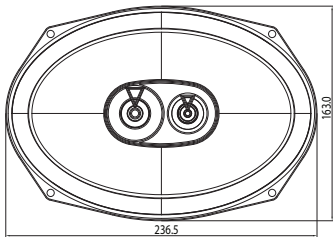
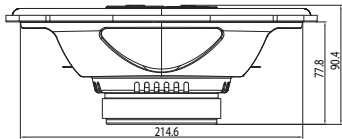

Specifications

- Type: 6"x9" (152mm x 230mm) three-way car speaker
- Power Handling: 85W RMS, 255W peak
- Sensitivity (@ 2.83V): 93dB
- Frequency Response: 50Hz – 20kHz
- Nominal Impedance: 3.0 ohms

Thiele-Small Parameters

- BL (Tm): 4.063
- DCR (ohms): 2.63
- Mms (g): 23.163
- Sd (cm²): 226.98
- Cms (μm/N): 0.337
- Vas (l): 24.5866
- Fs (Hz): 56.9
- Qes: 1.321
- Qms: 11.751
- Qts: 1.188
- Crossover Point: 3kHz



HARMAN International
Industries, Incorporated, 8500
Balboa Boulevard, Northridge,
CA 91329 USA

© 2019 HARMAN International
Industries, Incorporated.

All rights reserved. JBL is a

trademark of HARMAN International Industries, Incorporated,
registered in the United States and/or other countries.

Features, specifications and appearance are subject to change
without notice.